



CQD15S

Electric Stand-up Reach Truck 1.5t

- Best Choice for Stacking in Narrow Aisles & High Racking;
- Stand-on Operation Provides Broader View;
- Electric Power Steering Control, Comfortable and Efficient;
- None-floating drive system, solid stable in high position

EP EQUIPMENT CO.,LTD
www.ep-ep.com

Electric Reach Truck 1.5t CQD15S

Distinguishing mark				
1.1	Manufacturer			EP
1.2	Model designation			CQD15S
1.3	Drive unit			Battery
1.4	Operator type			standing
1.5	rated capacity	Q	t	1.5
1.6	Load center distance	c	mm	600
1.9	Wheelbase	y	mm	1504
Weight				
2.1	Service weight (include battery)		kg	2370①
2.2	Axle loading, fork advanced, unladen driving side/loading side		kg	1229/1230
2.3	Axle loading, fork retracted, unladen driving side/loading side		kg	1621/846
2.4	Axle loading, fork advanced, laden driving side/loading side		kg	490/3445
2.5	Axle loading, fork retracted, laden driving side/loading side		kg	1510/2416
Types, Chassis				
3.1	Tyre type driving wheels/loading wheels			polyurethane
3.2	Tyre size, driving wheels (diameter×width)		mm	Φ260×105
3.3	Tyre size, loading wheels (diameter×width)		mm	Φ254×114
3.4	Tyre size, caster wheels (diameter×width)		mm	Φ178×73
3.5	Wheels, number driving, caster/loading (x=drive wheels)			1, 2, 2
3.6	Track width, front, driving side	b ₁₀	mm	700
3.7	Track width, rear, loading side	b ₁₁	mm	974
Dimensions				
4.1	Tilt of mast/fork carriage forward/backward	α/ β	°	2/4
4.2	Height, mast lowered	h ₁	mm	2050②
4.3	Free lift (load backrest)	h ₂	mm	0②
4.4	Lift height	h ₃	mm	3000②
4.5	Height, mast extended	h ₄	mm	3860②
4.7	Height of overhead guard (cabin)	h ₆	mm	2255
4.8	Seat height/standing height	h ₇	mm	335
4.10	Height of wheel arms	h ₈ (mm)	mm	280
4.19	Overall length (minimum)	l ₁	mm	2335③
4.20	Length to face of forks	l ₂	mm	1265③
4.21	Overall width	b ₁ / b ₂	mm	1078/1090
4.22	Fork dimensions	s/ e/ l	mm	40×100×1070
4.23	Fork carriage class/type A, B			A
4.24	Fork carriage width	b ₃	mm	830
4.25	Outside width of the forks	b ₅	mm	200-620
4.26	Distance between wheel arms/loading surfaces	b ₄	mm	750
4.28	Reach distance	l ₄	mm	665③
4.31	Ground clearance, laden, below mast	m ₁	mm	70
4.32	The minimum ground clearance of frame	m ₂	mm	70
4.34.1	Aisle width for pallets 1000 × 1200 crossways	Ast	mm	2745③
4.34.2	Aisle width for pallets 800 × 1200 lengthways	Ast	mm	2770③
4.35	turning radius	Wa	mm	1765
4.37	Length across wheel arms (exclusive fork)	l ₇	mm	1912
Performance data				
5.1	Travel speed, laden/ unladen		km/ h	8.5/9
5.2	Lifting speed, laden/ unladen		m/ s	0.28/0.44
5.3	Lowering speed, laden/ unladen		m/ s	0.52/0.48
5.4	Reaching speed, laden / unladen		m/ s	0.1/0.1
5.8	Max. gradeability, laden/unladen		%	8/10
5.10	Service brake type			Electromagnetic
	Park brake type			Electromagnetic
Electric engine				
6.1	Drive motor rating S2 60 min		kW	4
6.2	Lift motor rating at S3 15%		kW	8.2
6.3	The maximum allowed size battery		mm	1030×353×784
6.4	Battery voltage/nominal capacity K5		V/ Ah	48V/420Ah④
6.5	Battery weight		kg	739④
Addition data				
8.1	Type of drive unit			AC
10.5	Steering type			Electronic
10.7	Sound pressure level at the driver's ear		dB (A)	75

If there are improvements of technical parameters or configurations, no further notice will be given.
The diagram shown may contain non-standard configurations.

①Service weight (include battery)

CQD15S		3-stage mast	
Mast height (mm)	Service weight (kg)		
2-stage mast		4000	2510
2700	2345	4500	2540
3000	2370	5000	2570
3300	2395	5500	2600
3640	2420	6000	2630
4000	2445	6500	2660
4300	2470	7000	2650
		7500	2680

②Mast

CQD15S : without side shift			
2-stage mast			
Lift height	Lowered mast height	Extended mast height	
h3	h1	h4	h4(*)
2700	1900	3560	3266
3000	2050	3860	3566
3300	2200	4160	3866
3640	2370	4500	4206
4000	2550	4860	4566
4300	2700	5160	4866

Note: (*) for without backrest

CQD15S : 3-stage mast					
Lift height	Lowered mast height	Free lift		Extended mast height	
h3	h1	h2	h2(*)	h4	h4(*)
4000	1930	1060	1060	4860	4700
4500	2100	1240	1240	5360	5200
5000	2270	1400	1400	5860	5700
5500	2440	1580	1580	6360	6200
6000	2610	1740	1740	6860	6700
6500	2780	1920	1920	7360	7200
7000	2950	2080	2080	7860	7700
7500	3120	2260	2260	8360	8200

Note: (*) for without backrest

CQD15S : with side shift			
2-stage mast			
Lift height	Lowered mast height	Extended mast height	
h3	h1	h4	h4(*)
2700	1900	3735	3266
3000	2050	4035	3566
3300	2200	4335	3866
3640	2370	4675	4206
4000	2550	5035	4566
4300	2700	5335	4866

Note: (*) for without backrest

CQD15S : 3-stage mast					
Lift height	Lowered mast height	Free lift		Extended mast height	
h3	h1	h2	h2(*)	h4	h4(*)
4000	1930	895	1060	5035	4700
4500	2100	1065	1240	5535	5200
5000	2270	1235	1400	6035	5700
5500	2440	1405	1580	6535	6200
6000	2610	1575	1740	7035	6700
6500	2780	1745	1920	7535	7200
7000	2950	1915	2054	8035	7700
7500	3120	2085	2234	8535	8200

Note: (*) for without backrest

④Battery

CQD15S	
Capacity(Ah)	Battery weight (kg)
300	600
345	560
360	620
420	739
450	739
465	739

③Dimensions(mm)

		without side shift		with side shift	
		2-stage mast	3-stage mast	2-stage mast	3-stage mast
Overall length (minimum)	I1	2335	2357	2370	2392
Length to face of forks	I2	1265	1287	1300	1322
Reach distance	I4	665		630	
Aisle width for pallets 1000×1200 crossways	Ast	2745	2760	2763	2783
Aisle width for pallets 800×1200 lenthways	Ast	2770	2790	2801	2820
Aisle width for pallets 1000×1200 lenthways	Ast	2825	2843	2853	2872
Aisle width for pallets 800×1200 crossways	Ast	2635	2645	2651	2662

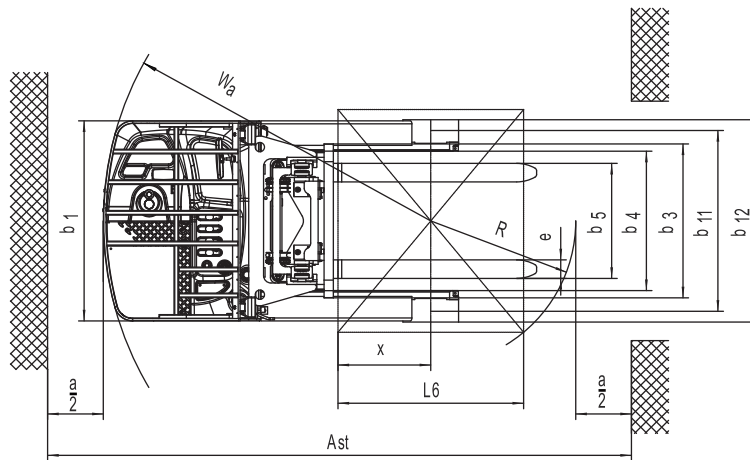
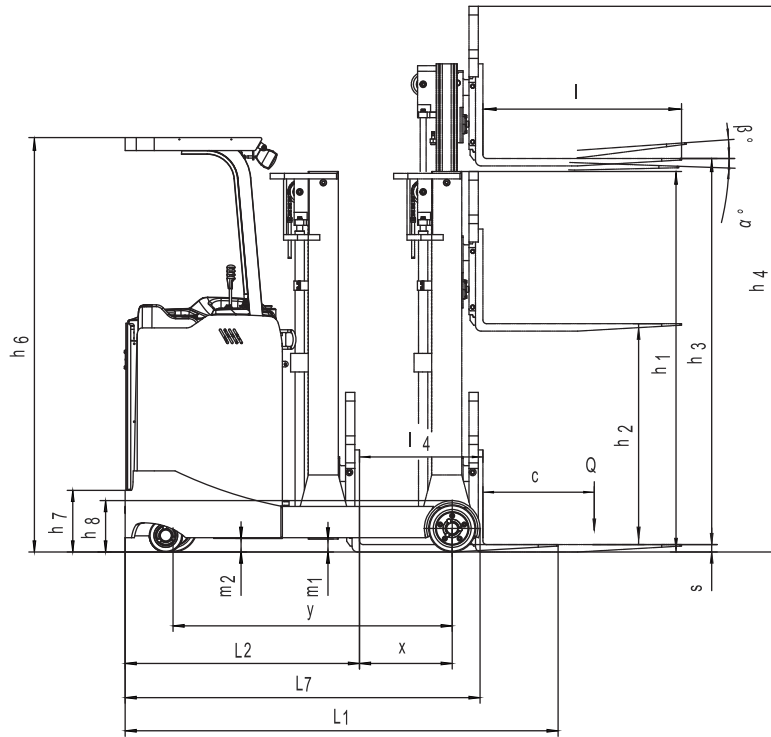

RATED CAPACITIES GRAPH

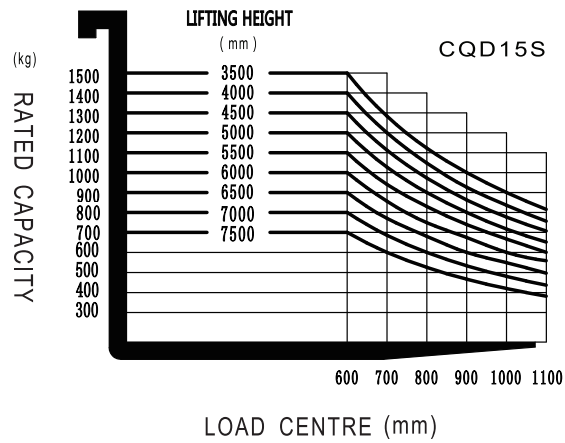

Option

Options	CQD15S
Driving pedal	—
Electronic Power steering	●
Battery capacity	●420Ah ○300/345/360/465Ah
Lithium Battery capacity	○260Ah
Lateral change battery	○
Cold storage	○
Side shift	○
Front light and warning light	●
Rearview mirror	●
Hummer	○
Height display	—
Camera	○
Fire extinguisher	○
The front wheel side guard	○
Drive-in Rack	○
Seat switch	—
Water auto-fillingsystem	
Note: ● standard ○ option — NA	

